

# *User's Guide to the OFI-3*

*Optical Fiber Identifier*

# ***User's Guide to the OFI-3***

---

*Optical Fiber Identifier*

# **CONTENTS**

# **PAGE**

---

■	<b>1 Introduction</b>	.....	1
■	<b>2 Warranty</b>	.....	2
	2.1 Three Years Limited Warranty		
	2.2 Exclusions		
	2.3 Returning Product		
	2.4 Contacting us		
■	<b>3 Safety Information</b>	.....	4
■	<b>4 Preparing for Operation</b>	.....	5
	4.1 Unpacking the instrument		
	4.2 Battery		
■	<b>5 Operation</b>	.....	7
	5.1 Controls and connectors		
	5.2 Powering on the instrument		
	5.3 Traffic detecting		
	5.4 Frequency detecting		
	5.5 Signal intensity		
	5.6 Self-calibrating		
■	<b>6 Specifications</b>	.....	14
■	<b>7 Maintenance</b>	.....	16



### 1 Introduction

The OFI-3 optical fiber identifier is an inexpensive, portable instrument designed to identify optical test tones and live traffic without disconnecting live system. By simply clamping the OFI-3 onto a fiber, the instrument will indicate if there is a signal, or traffic and show the signal direction. It can detect a variety of optical tones, 270Hz, 1KHz and 2KHz.

The OFI-3 is recommended for both 0.25/0.9 mm bare fiber and 3mm jacketed fiber. When testing jacketed fibers, the slim design of the OFI-3 allows easier access to a splice tray where the amount of workspace is limited. The clamping trigger is designed to fit the natural motion of the operator's hand. The instrument is ruggedly constructed and reliable to use.

## **2 Warranty**

### **Three Years Limited Warranty**

Grandway products are warranted against the defective components and workmanship for a period of three years from the date of delivery to the original customer. Any product found to be defective within the warranty period would be returned to Grandway authorized service center for repair, replacement and calibration.

### **Exclusions**

The warranty on your equipment shall not apply to defects resulting from the following:

- Unauthorized repair or modification
- Misuse, negligence, or accident

### **Returning Product**

To return product, you may contact Grandway to obtain additional information if necessary.

To serve you better, please specify the reasons for the return.

All delivery and mails should be sent to the following address:

Grandway Customer Service  
6F, Xin'an building No. 99 Tianzhou Road  
Shanghai, 200233 P.R. China

### **Contacting Us**

Tel: 0086-21-54451260/61/62/63

Fax: 0086-21-54451266

E-mail: [heyong@grandway.com.cn](mailto:heyong@grandway.com.cn)

or

[shiwei@grandway.com.cn](mailto:shiwei@grandway.com.cn)

Website: [www.grandway.com.cn](http://www.grandway.com.cn)

### **3 Safety Information**

#### **Warnings!**

- Never look directly into optical outputs or a fiber while the equipment is on. Invisible laser beam may damage your eyes.
- Do not short-circuit the terminal of AC adapter / charger and the batteries. Excessive electrical current may cause personal injury due to fumes, electric shock or equipment damage.
- Connect AC power cord with the equipment and wall socket properly. While inserting the AC plug, make sure there is no dust or dirt on the terminals and both plugs are fully seated. Incomplete engagement may cause fuming, electric shock or equipment damage and may result in personal injury.
- Do not operate the equipment near hot objects, in hot environments, in dusty/ humid atmosphere or when condensation is present on the equipment. This may result in electric shock , product malfunction or poor performance.

## **4 Preparing for Operation**

### **4.1 Unpacking the instrument**

#### **Packing material**

We suggest that you keep the original packing material. Using the original packing material is your guarantee of protecting the instrument during transit.

#### **Checking the package contents**

The standard accessories of OFI-3 are as follows:

- Main unit
- Plungers
- Carrying Case
- User's Guide
- 2\*1.5V Alkaline Batteries
- Quality Check Report

#### **Checking for damage in transit**

After unpacking the instrument, check to see whether it was damaged in transit. This is particularly likely if the outer casing is clearly damaged. If there is damage, do not attempt to operate the instrument or to repair it without authorization. Doing so can cause further damage and you may lose your warranty qualification.

### 4.2 Battery

The OFI-3 instrument is powered by two 1.5V AA batteries. There is a “Low” battery indicator on the panel board. It turns on if there is not enough power to supply the instrument. That is when you should replace the battery with a new one. To replace the battery, please remove the battery plate on the back side of the instrument with a screwdriver.



**Note:** 1 It is advisable to use 1.5V alkaline batteries. The Low Battery Indicator may light up if you use rechargeable batteries.

2 To eliminate the possibility of acid leakage, please take out the batteries if the unit is not used for a long time.

## 5 Operation

### 5.1 Controls and connectors

#### 5.1.1 Front (Panel Board)

No.	Key / Indicator	Note
1	Plunger	Three available types: RB0.25mm, RB0.9mm, RB3.0mm.
2	Fiber Groove	A slot to place tested fiber.
3	PD Headstock	
4	No Signal Indicator	Lights up if there is not a signal in tested fiber.
5	Left Traffic Indicator	Lights up if the signal in tested fiber is from right to left.
6	Right Traffic Indicator	Lights up if the signal in tested fiber is from left to right.
7	Signal Intensity Indicator	To show the signal intensity level. The higher, the stronger.
8	2kHz Indicator	Lights up if the wave frequency is 2kHz.
9	1kHz Indicator	Lights up if the wave frequency is 1kHz.
10	270Hz Indicator	Lights up if the wave frequency is 270Hz.
11	Low Battery Indicator	Lights up when there is not enough power.
12	Adjusting Key	Self-calibrates.

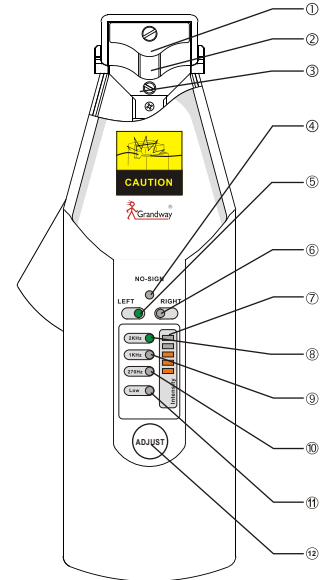

### 5.1.2 Back & Side

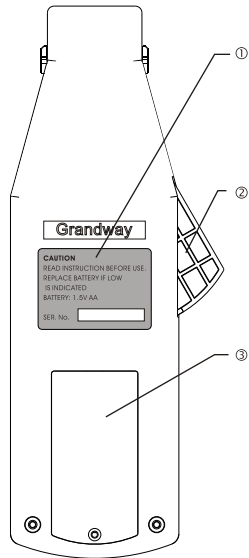

1	Serial Number
2	Clamping Trigger
3	Battery Plate

### 5.2 Powering on the instrument

Gently insert the tested fiber into the groove at the top of instrument. Pull the clamping trigger slowly to depress the fiber against the optical assembly. The instrument powers on when the detector plunger has closed and the fiber is in the appropriate position.

**Note:** Please be careful while placing the fiber in the provided slot. Force the fiber into the headstock. Misaligning the fiber may induce optical losses above what the specification demonstrates.

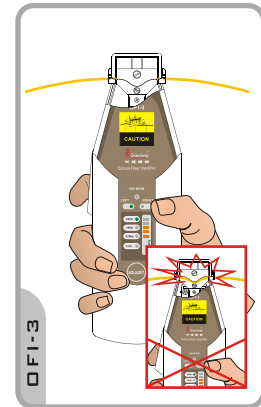
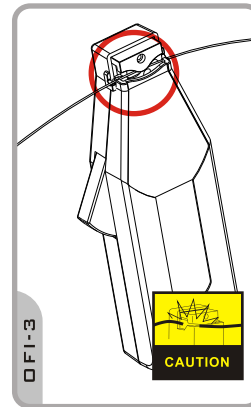

### 5.3 Traffic detecting

If the tested fiber is carrying signal, a Traffic Indicator illuminates to show the direction, left or right.

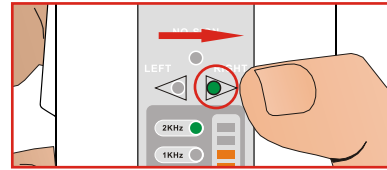
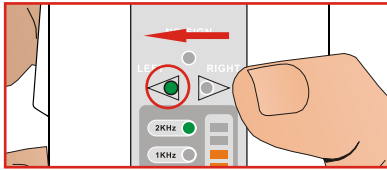

When no signal is present or the signal to be tested is too weak for the instrument to detect, the No Signal Indicator illuminates.

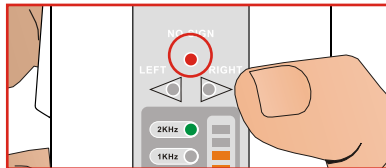

## 5.4 Frequency detecting

If the tested fiber is carrying 2kHz, 1kHz or 270Hz modulated wave, the respective modulation indicator illuminates and the instrument makes a buzzing sound.

**Note:** The instrument may not recognize the frequency correctly if the signal is too weak or the frequency is not stable.

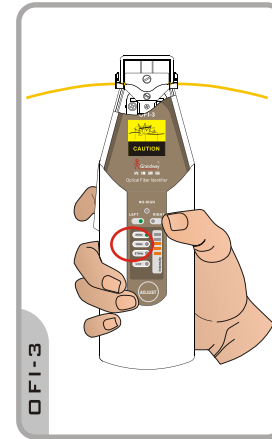

### 5.5 Signal intensity

The signal intensity indicator on the panel board lights up to tell you how strong the signal is. There are 5 LEDs aligning in a line. More of them illuminate meaning the signal is stronger.

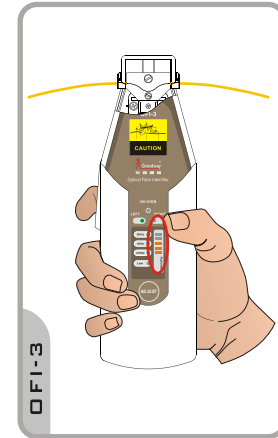

## 5.6 Self-calibrating

The instrument may need a little adjustment after long-term disuse or a sudden change of the environment such as temperature or light variation. Change the plunger to the RB0.25 type, pull the clamping trigger, then press the "Adjust" key shortly to start the self-calibration which lasts about 10-30 seconds. When it finishes, the instrument makes a buzzing sound and the "No Signal" Indicator blinks.

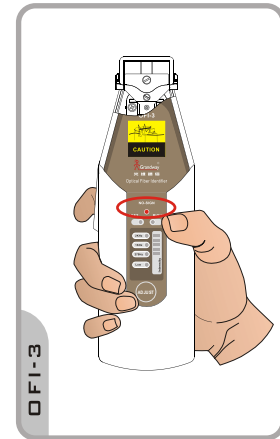
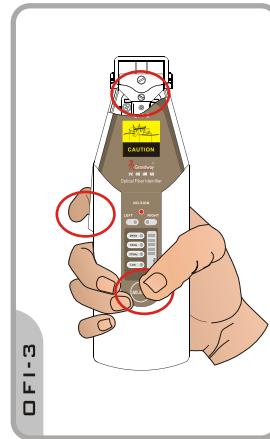

## 6 Specifications

### Optical Specifications

Model	OFI-3
Recognizable Wavelength Range	900nm - 1650nm
Recognizable Signal Type	CW,270Hz±5%,1KHz±5%,2KHz±5%
Detector Type	InGaAa 2pcs
Available Plunger	RB 0.9 for bare fibers RB 0.25 for tightly buffered fibers RB 3.0 for jacketed fibers
Detecting Sensitivity	≤-50dBm
Power	2*1.5V AA batteries

Sensitivity (Minimum recognizable optical power intensity in the fiber)	1310nm(typical)	1550nm(typical)
Continuous Wave	-23dBm	-30dBm
2KHz Modulated Wave Detection	-10dBm	-18dBm
1KHz Modulated Wave Detection	-10dBm	-18dBm
270Hz Modulated Wave Detection	-10dBm	-18dBm

**General Specifications**

Operation Temperature	0°C~+40°C
Storage Temperature	-10°C~+70°C
Size(H*W*D)	3.6cm*6.2cm*20.2cm
Weight	0.27kg

## 7 Maintenance

- 1. All the specifications of OFI-3 series are tested with cleaned Corning SMF-28TM/SMF-D pure non-dispersion coated fiber. The testing performance will be affected when using different brands or types of fibers with various coating color.
- 2. Please do not bend the fiber excessively; which may lead to misjudgment on traffic or even breaking the fiber.

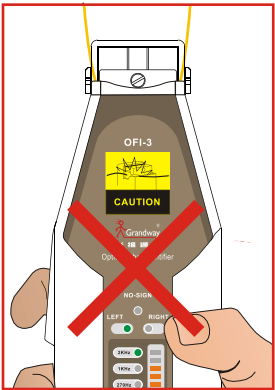
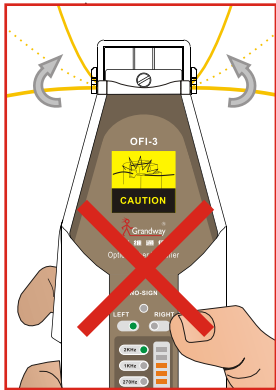

3. Keep the optical receiver clean and use cleaning oil when testing bare fiber to achieve the best performance.

4. To clean the optical assembly, remove the clamp and gently clean the prism and optical windows using cleaning pads and cleaning oil. Do not immerse the plunger assembly in alcohol.

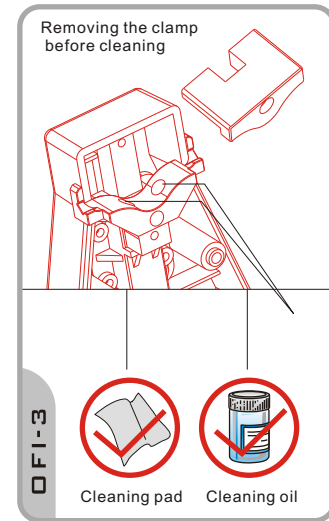

**NOTE:** Specifications, terms and conditions are subject to change without notice.  
©Copyright 2006 Grandway. All rights reserved.  
Grandway and its logo are trademarks of Grandway.

Printed in China.